

規格承認書

SPECIFICATIONS FOR APPROVAL

客戶
CUSTOMER : Ropla Elektronik Sp. z o.o.

項目
ITEM : Metallized Polypropylene Film AC Capacitor
(Interference Suppressors Class-X2) TYPE: MPX2

客戶料號
CUSTOMER'S PART NO. :

優普料號
EUROPTRONIC'S P/N : MPX2 305VAC SERIES (ROHS環保產品)

日期
ISSUED DATE : 2011-11-24

版本
EDITION : A

※ This specification will be invalidated assuming that it is not accepted when it is not returned within one year from the date of issue.

CUSTOMER'S ISSUED :

優普電子(蘇州)有限公司
EUROPTRONIC (SUZHOU) CO., LTD.

優普電子(深圳)有限公司
EUROPTRONIC ELECTRONIC (SHENZHEN) CO. LTD.



優普集團

EUROPTRONIC GROUP

REVISION LIST

NO.	DATE	CHANGE CONTENT	REMARK
1	2011-11-24	First Editon	A
2			
3			
4			
5			
6			
7			
8			
9			
10			
11			
12			
13			
14			
16			
17			
18			
19			
20			
21			
22			
23			
24			
25			



EXAMPLE : MPX2 0.047 uF ±10% 305 VAC Lead Space:7.5mm

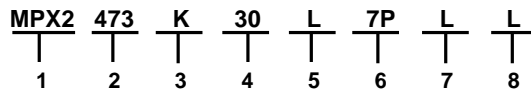

1. TYPE OF CAPACITOR : Expressed in 4-letter code

TYPE	PEI	PEN	PENM	DMPE	MPEM	EMPE	MPEB	FMPE	TMPE	DMPC	PPL	PPN	PPNM	MPP	MPPB	MPPM	MPH	MPA
CODE	PEI-	PEN-	PENM	DMPE	MPEM	EMPE	MPEB	FMPE	TMPE	DMPC	PPL-	PPN-	PPNM	MPP-	MPPB	MPPM	MPH-	MPA-
TYPE	MPLB	MPHB	PPSB	MPX2	MPX	FMPP	TMPP	MPPS	PPSM	MPSA	MPFA	PPNB	MMPE	MPHT	DMPT	MPLT		
CODE	MPLB	MPHB	PPSB	MPX2	MPX-	FMPP	TMPP	MPPS	PPSM	MPSA	MPFA	PPNB	MMPE	MPHT	DMPT	MPLT		

2. CAPACITANCE (EIA Code) : Expressed in 3-digit code

The first 2 digits indicate significant figures, and the third digit specifies the number of zero to follow. This gives the capacitance in picofarads. For examples: 102 = 1,000pF = 1.0nF = 0.001uF 103 = 10,000pF = 10nF = 0.01uF
 104 = 100,000pF = 100nF = 0.1uF 105 = 1,000,000pF = 1,000nF = 1.0uF 106 = 10,000,000pF = 10,000nF = 10uF

3. TOLERANCE (EIA Code) : Expressed in 1-letter code

TOLERANCE	± 1%	± 2%	± 3%	± 5%	± 10%	± 20%	+80%-20%	+100%-0%
CODE	F	G	H	J	K	M	Z	P

4. RATED VOLTAGE : Expressed in 1digit-1-letter code for VDC and 2-digit code for VAC

VDC	4.0V	6.3V	10V	16V	25V	35V	50V	63V	80V	100V	160V	200V	250V	300V	350V	400V	450V	500V
CODE	0G	0J	1A	1C	1E	1V	1H	1J	1K	2A	2C	2D	2E	2F	2V	2G	2W	2H
VDC	520V	550	600	630V	700V	800V	850V	900V	1000V	1200V	1250V	1500V	1600V	1800V	2000V	2500V	3000V	3500V
CODE	2X	2Y	2R	2J	2S	2K	2T	2U	3A	3M	3B	3N	3C	3Q	3D	3E	3F	3V
VAC	125	180	200	220	230	250	275	280	305	320	350	370	400	440	450	500	600	700
CODE	12	18	20	22	23	25	27	28	30	32	35	37	40	44	45	50	60	70
VAC	800	900																
CODE	80	90																

5. LEAD CONFIGURATION : Expressed in 1-letter code

CODE	L	B	C	D	E	F	G	H	Y	T	U
LEAD TYPE											
CODE	A										
LEAD TYPE											

6. LEAD SPACE : Expressed in 2-digit or 1-digit-1-letter code

Unit : mm

LEAD SPACE	3.0	3.5	4.0	4.5	5.0	5.5	6.0	6.5	7.0	7.5	8.0	8.5	9.0	9.5	10.0	12.5	15.0
CODE	03	3P	04	4P	05	5P	06	6P	07	7P	08	8P	09	9P	10	12	15
LEAD SPACE	17.5	20.0	22.5	25.0	27.5	30.0	32.5	35.0	37.5	36.5	42.5	52.5					
CODE	17	20	22	25	27	30	32	35	37	36	42	52					

7. LEAD FORMING PITCH : Expressed in 1-letter code

LEAD PITCH	5.0	7.5	10.0	12.5	15.0	17.5	20.0	22.5	25.0	27.5	30.0	35.0	37.5	Others	N/A
CODE	A	H	B	G	C	N	D	W	E	F	U	V	Z	X	L

8. LEAD LENGTH (Straight): Expressed in 1-letter code Taping



Unit : mm

LEAD LENGTH	3.1	3.5	4.0	4.5	5.0	5.5	7.5	8.0	9.0	3.2	2.2	3.8	6.0	7.0	11.5	12.0	4.1
CODE	1	2	3	4	5	6	7	8	9	X	A	B	C	D	E	F	G
LEAD LENGTH	15.0	22.0	25.0	30.0	35.0	28.0	2.7	40.0	29.0	45.0	20.0	26.0	6.5	3.4	Taping	N/A	其他
CODE	H	J	K	M	N	P	Q	R	S	T	U	V	W	Y	T	L	0

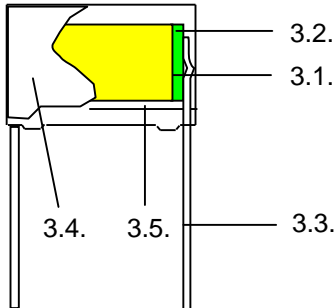

PRODUCT SPECIFICATIONS

TYPE : MPX2

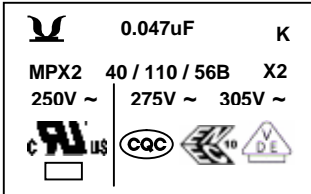
NO.	ITEM	DESCRIPTIONS
1.	SCOPE	This specifications cover the requirements of EUROPTRONIC's Metallized Polypropylene Film AC Capacitor (Interference Suppressors Class-X2), Type : MPX2
2. STANDARD ATMOSPHERIC CONDITIONS FOR MAKING MEASUREMENTS		
2.1.	AMBIENT TEMPERATURE	15°C to 35°C (If there is any doubt on the results, the measurements shall be made at +20 +/- 5°C.)
2.2.	RELATIVE HUMIDITY (R.H.)	45% to 75% (If there is any doubt on the results, the measurements shall be made at 60% to 70%.)
2.3.	AIR PRESSURE	86 kpa to 106 kpa.
2.4.	OPERATING TEMPERATURE RANGE	-40°C to +110°C for which the capacitor can be operated continuously at rated voltage.
3. CONSTRUCTION		
3.1.	DIELECTRIC	Metallized Polypropylene Film
3.2.	METAL SPRAY	Special Solder
3.3.	LEAD WIRE	Copper-clad Steel Wire
3.4.	PLASTIC CASE	UL94V-0
3.5.	EPOXY RESIN	UL94V-0
		
4. MARKING		
4.1.	MANUFACTURER'S SYMBOL	 stands for EUROPTRONIC GROUP.
4.2.	TYPE OR MATERIAL	"MPX2" stands for MPX2 type.
4.3.	CAPACITOR CLASS	"X2" stands for X2 class
4.5.	NOMINAL CAPACITANCE	Capacitance value in uF.
4.6.	TOLERANCE	"K" for +/-10%; "M" for +/-20%.
4.7.	RATED VOLTAGE	in VAC rating.
4.8.	APPROVAL BRANDS	UL/C-UL,VDE,ENEC,.CQC
4.9.	MANUFACTURER CODE	
		

5. ELECTRICAL CHARACTERISTICS				
NO.	ITEM		PERFORMANCE	TEST CONDITIONS
5.1.	Withstand Voltage (TV)	Between Terminals	Shall be no abnormality.	Apply 1312VDC for 60 sec or 2150VDC for 2 sec, Charge current must be 1A max. Withstanding (DC) voltage (cut off current 10mA), rise time 100V/S .
		Between Terminals & Enclosure	Shall be no abnormality.	Apply 2110VAC for 60sec.
5.2.	Insulation Resistance (I.R.)		>= 15,000 MOhm (C <= 0.33uF) >= 5,000 MOhm*uF/C (C > 0.33uF)	Apply 100V+/-15%for 60+/-5sec.at+20+/-2°C .
5.3.	Capacitance (CAP)		Within the tolerance specified. (at +20 +/- 5°C).	Measuring Frequency : 1 KHz +/- 10%. Measuring Voltage : 1 Vrms.max.
5.4.	Dissipation Factor (DF)		0.001 (0.1%)max. at 1 KHz.	Measuring Frequency : 1 KHz +/- 10%. Measuring Voltage : 1 Vrms.max.
5.5.	Solderability		More than 95% of circumferential surface of lead wire shall be covered with new solder.	Testing method per IEC 68-2-20 Ta. Soldering temperature : +245 +/- 5°C. Immersion duration : 2 +/- 0.5 sec.
6. MECHANICAL CHARACTERISTICS				
NO.	ITEM		PERFORMANCE	TEST CONDITIONS
6.1.	Terminal Strength	Tensile	Shall be no abnormality.	Testing method per IEC 68-2-21. Apply 1.0 kg for 10 +/- 1sec. to the terminal in the axial direction, and acting in a direction away from the body.
		Bending	Shall be no abnormality.	Apply 0.5 kg for 2 cycles. Each cycle includes: 90° once, return to its initial position for 2-3 sec., and then to the opposite direction once.
7. ENDURANCE CHARACTERISTICS				
NO.	ITEM		PERFORMANCE	TEST CONDITIONS
7.1.	Temperature Cycle	Appearance	Shall be no remarkable change.	Test Temperature Cycle : Total 5 cycles. Each cycle includes : 1. +20 +/- 2°C for 3min. 2. -40 +0/-3 °C for 30 min. 3. +20 +/- 2°C for 3min. 4. +110 +3/-0 °C for 30 min. 5. +20 +/- 2°C for 3 min.
		Withstand Voltage	Shall satisfy No. 5.1.	
		Capacitance Change Rate ($\Delta C/C$)	Within +/- 5% of the value before test.	
		DF change($\Delta tg\delta$)	<=80*10 ⁻⁴ at 1 KHz.	
		Insulation Resistance (I.R.)	>= 50% of the limit value of No. 5.2.	



優普集團

EUROPTRONIC GROUP

NO.	ITEM	PERFORMANCE	TEST CONDITIONS
7.2.	High Temperature Loading	Appearance	Shall be no remarkable change.
		Withstand Voltage	Shall satisfy No. 5.1.
		Capacitance Change Rate ($\Delta C/C$)	Within +/-10% of the value before test.
		DF change($\Delta tg\delta$)	$\leq 80 \times 10^{-4}$ at 1 KHz.
		Insulation Resistance (I.R.)	$\geq 50\%$ of the limit value of No. 5.2.
			Testing method per IEC 60384-14. Refer to JIS C 5102-1994. Test Temperature : +110 +/-2 °C. Apply 125% of rated voltage for 1,000 +24/-0 hrs; After test, allow it stay alone for 4 hrs at standard temperature and humidity before making measurements.
7.3.	Humidity Resistance	Appearance	Shall be no remarkable change.
		Withstand Voltage	Shall satisfy No. 5.1.
		Capacitance Change Rate ($\Delta C/C$)	Within +/- 10% of the value before test.
		DF change($\Delta tg\delta$)	$\leq 80 \times 10^{-4}$ at 1 KHz.
		Insulation Resistance	$\geq 50\%$ of the limit value of No. 5.2.
			Testing method per IEC 68-2-3 Ca. Refer to JIS C 0022. Test Temperature : +40 +/- 2°C. Test Humidity : 90% to 95% R.H. Test Duration : 500 +24/-0 hrs After test, allow it stay alone 4 hrs at standard temperature and humidity before making measurements.
7.4.	Soldering Heat Resistance	Appearance	Shall be no remarkable change. The marking shall be legible.
		Withstand Voltage Between Terminals	Shall satisfy No. 5.1.
		Capacitance Change Rate ($\Delta C/C$)	Within +/- 5% of the value before test.
		DF change($\Delta tg\delta$)	$\leq 80 \times 10^{-4}$ at 1 KHz.
		Insulation Resistance (I.R.)	$\geq 50\%$ of the limit value of No. 5.2.
		Connection of Element	Shall be stable.
			Testing method per IEC 68-2-20 Tb. Soldering Temperature : +260 +/- 5°C. Immersion Duration : 10 +/- 1sec. Immersion Depth : 1.5 +/- 0.5 mm from roots. After test, allow it stay alone for 1.5 +/- 0.5 hrs. at standard temperature and humidity before making measurements.
7.5.	Dry Heat Resistance	Appearance	Shall be no remarkable change.
		Withstand Voltage	Shall satisfy No. 5.1.
		Capacitance Change Rate ($\Delta C/C$)	Within +/- 5% of the value before test.
		DF change($\Delta tg\delta$)	$\leq 80 \times 10^{-4}$ at 1 KHz.
		Insulation Resistance (I.R.)	$\geq 50\%$ of the limit value of No. 5.2.
			Test Temperature : +110 +/- 2°C Test Duration : 2 +1/-0 hrs.
7.6.	Cold Resistance	Appearance	Shall be no remarkable change.
		Withstand Voltage	Shall satisfy No. 5.1.
		Capacitance Change Rate ($\Delta C/C$)	Within +/- 5% of the value before test.
		DF change($\Delta tg\delta$)	$\leq 80 \times 10^{-4}$ at 1 KHz.
		Insulation Resistance (I.R.)	$\geq 50\%$ of the limit value of No. 5.2.
			Test Temperature : -40 +/-2 °C Test Duration : 2 +1/-0 hrs.







NO.	ITEM		PERFORMANCE	TEST CONDITIONS
7.7.	Vibration Resistance	Connection Strength	Shall be no open nor short-circuiting. The connection shall be stable.	Testing method per IEC 68-2-6 Fc. Frequency Change : 10--55--10 Hz. Vibration Distance : 1.5 mm. Test Direction : X, Y, Z. Test Duration : 2 +/- 0 hrs each direction.
		Appearance	Shall be no mechanical damage.	
7.8.	Rapid Temperature Change	Appearance	Shall be no remarkable change.	Testing method per IEC 68-2-14 Na. Test Temperature Cycle : Total 5 cycles. High Temperature : +110+/-5 °C Low Temperature : -40 +/-5°C 30 min +/- 10% for each temperature.
		Withstand Voltage	Shall satisfy No. 5.1.	
		Capacitance Change Rate ($\Delta C/C$)	Within +/- 5% of the value before test.	
		DF change($\Delta tg\delta$)	$\leq 80 \times 10^{-4}$ at 1 KHz.	
		Insulation Resistance	$\geq 50\%$ of the limit value of No. 5.2.	

8. ACCEPTABLE QUALITY LEVEL (AQL)

NO.	ITEM	AQL	SAMPLING PLAN
8.1.	Appearance AQL	0.65	According to MIL-STD-105E level II. GB2828-2003 level II. By lot outgoing inspection.
8.2.	Dimension AQL	0.65	
8.3.	Mechanical Characteristics AQL	0.40	
8.4.	Electrical Characteristics AQL		
	CAP, DF, TV, IR,	0.04 Zero Defect	

APPROVALS:

Mark	structure	File no
	UL / CUL	E307895 / E211347
	VDE	40025981
	ENEC	40025981
CB	VDE	DE1-43227/M1/A1
	CQC	CQC09001029511
	KTL	SU03025-1001、SU03025-1002、SU03025-1003、SU03025-1004、

容許交流電壓 VS 頻率曲線圖

TYPE: **MPX2**

Max. RMS Voltage as a function of frequency (typical curve)

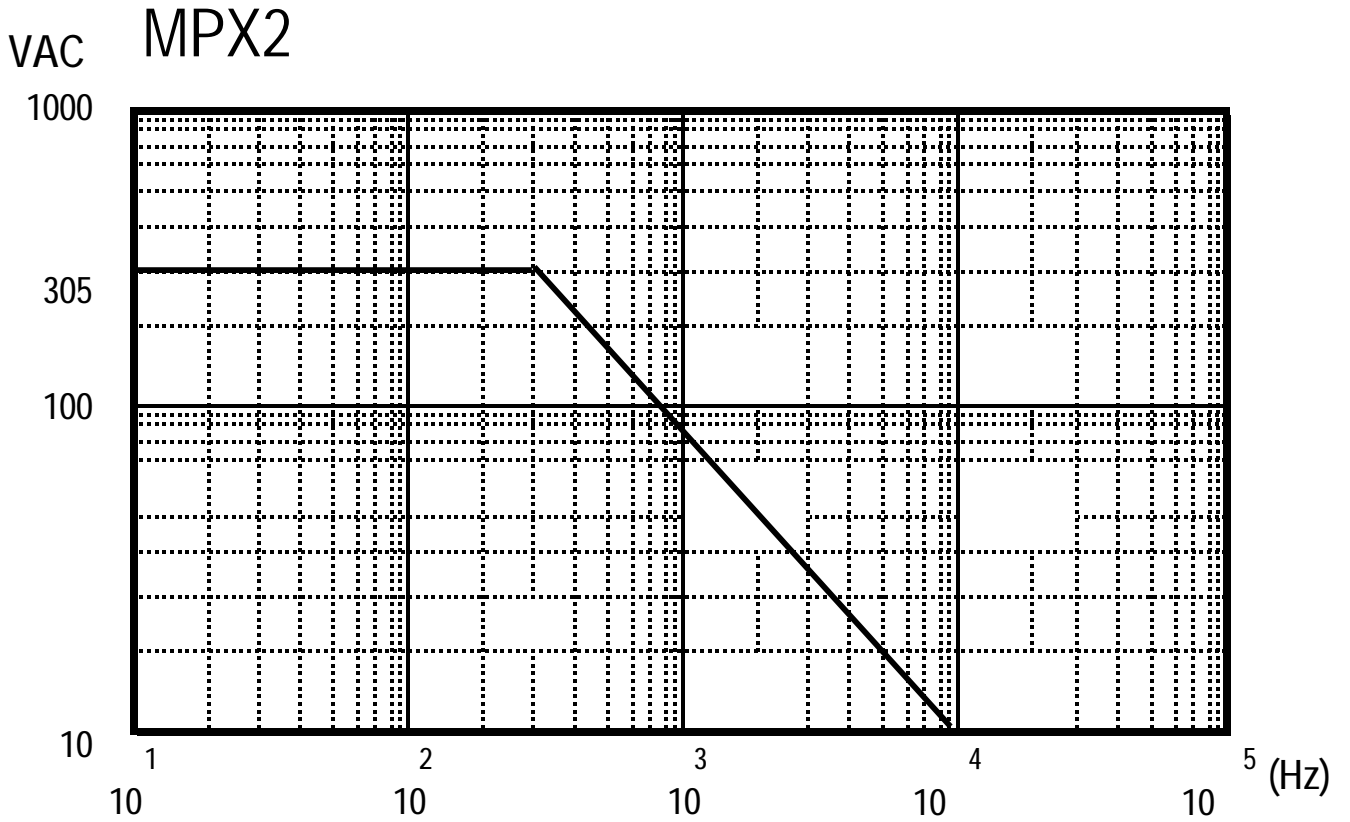

CHARACTERISTICS REFERENCE

Soldering Temperature VS Time

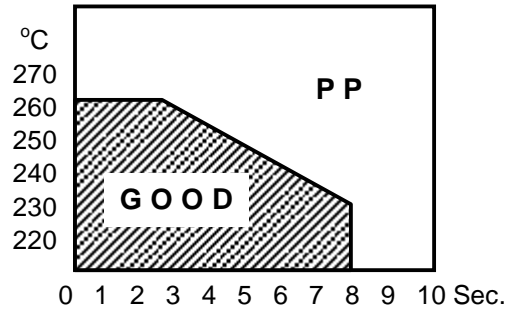
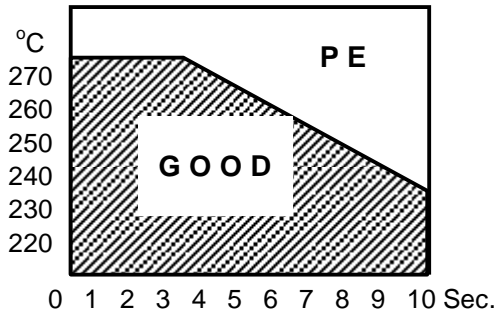

1.6E+09

Frequency Characteristics

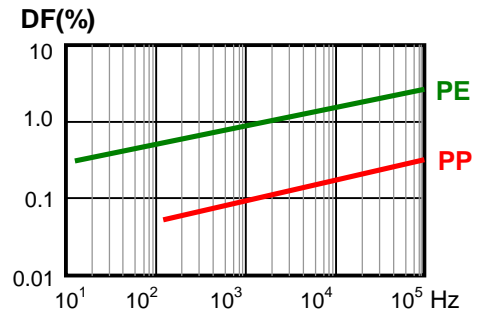
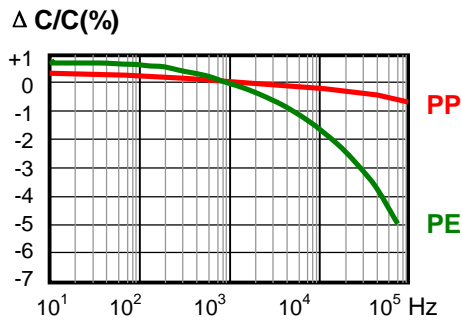

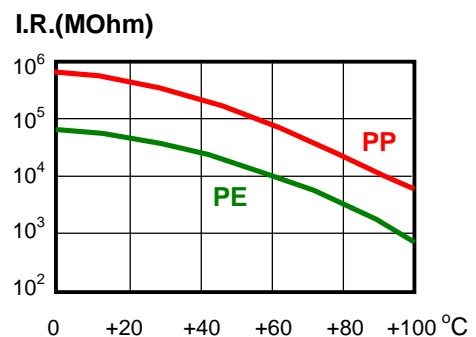
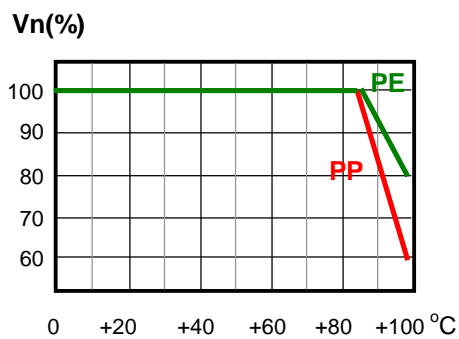
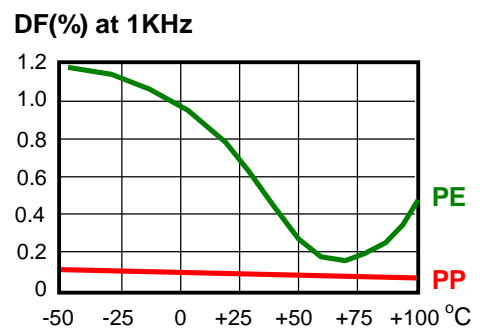
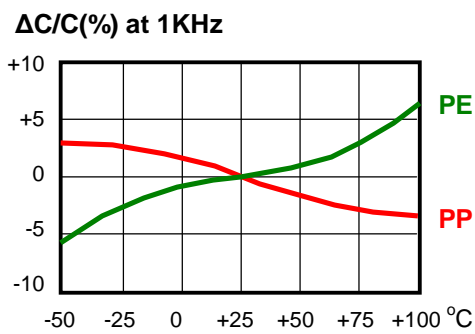

Temperature Characteristics

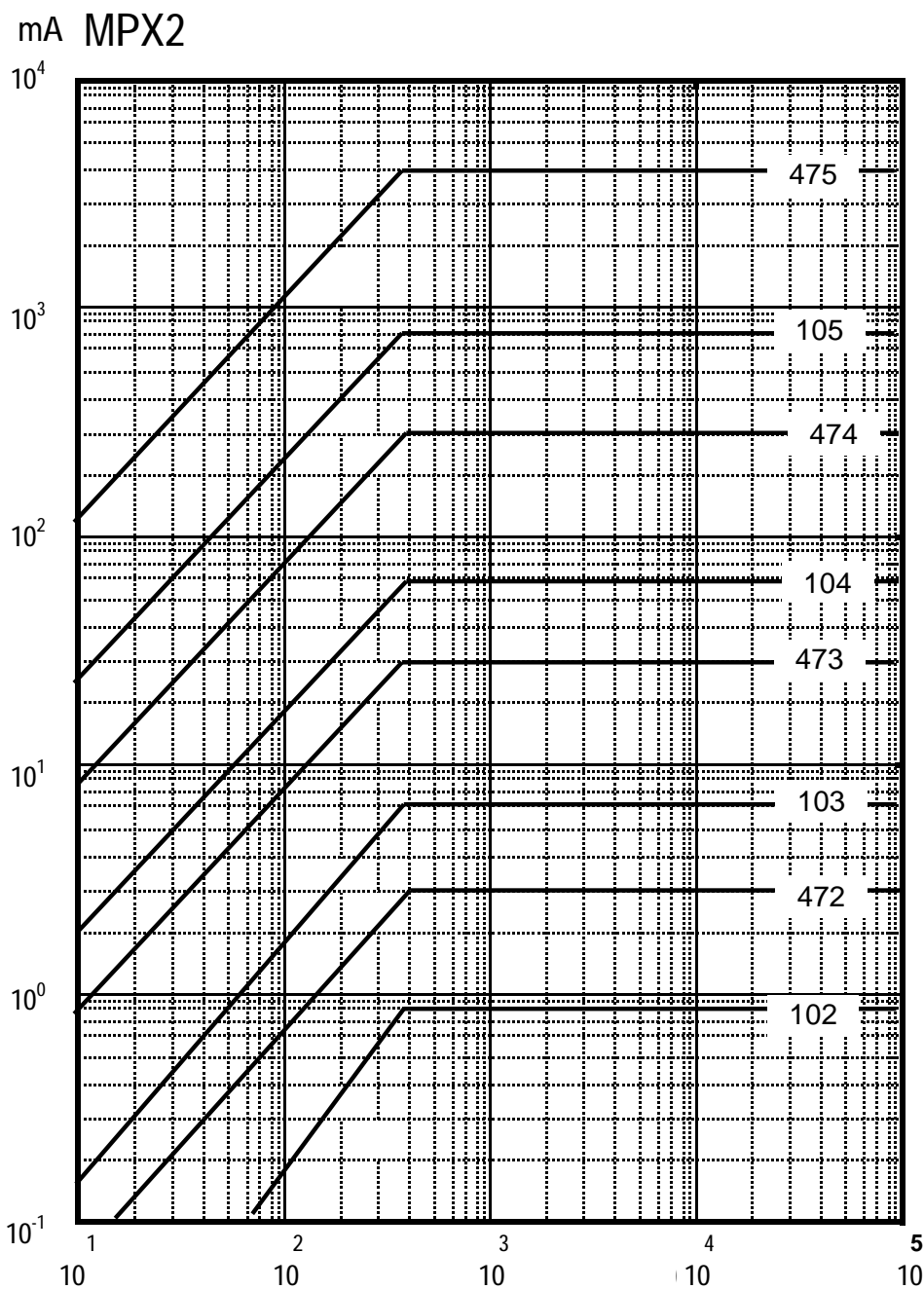

Max. RMS Current as a function of frequency (typical curve)

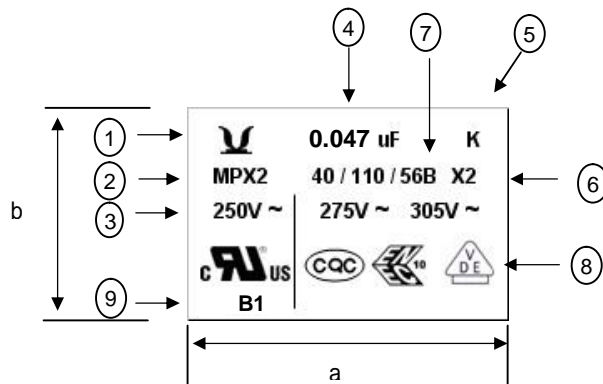



- 1 MANUFACTURER'S LOGO:  stands for EUROPTRONIC GROUP.
- 2 TYPE OF MATERIAL: "MPX2" stands for MPX2 type.
- 3 RATED VOLTAGE : in VAC rating.
- 4 NOMINAL CAPACITANCE: Capacitance value in uF.
- 5 TOLERANCE: in EIA 1-letter code (Please refer to"PART NUMBERING") .
- 6 CAPACITOR CLASS: "X2" stands for X2 class
- 7 CLIMATIC CATEGORY: "40/110/56B " stand for the climate category
- 8 APPROVAL BRANDS: UL,CUL,VDE,ENEC,CQC,KTL.
- 9 DATE CODE: Year&Month (Example B1: 2011,January)

Year	code	Month	code	Year	code	Month	code
2000	M	1	1	2012	C	1	1
2001	N	2	2	2013	D	2	2
2002	P	3	3	2014	E	3	3
2003	R	4	4	2015	F	4	4
2004	S	5	5	2016	H	5	5
2005	T	6	6	2017	J	6	6
2006	U	7	7	2018	K	7	7
2007	V	8	8	2019	L	8	8
2008	W	9	9	2020	M	9	9
2009	X	10	A			10	A
2010	A	11	E			11	E
2011	B	12	H			12	H



Inner Box (Lead Cut)

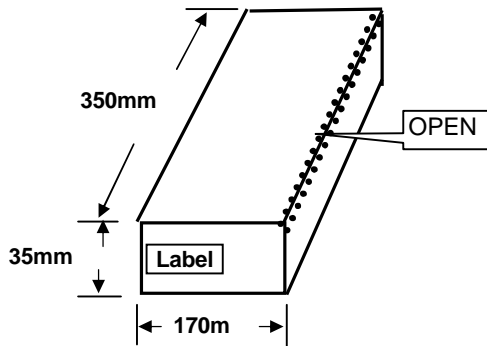

Lead Cut

Label:

- 1.Customer P/N
- 2.Eurotronic P/N
- 3.Specification
- 4.Quantity
- 5.Net weight
- 6.Date

Inner Bag (Long Lead)

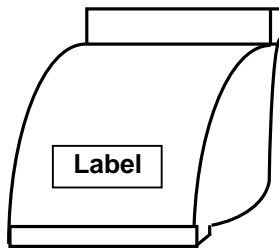

Long Lead

Label:

- 1.Customer P/N
- 2.Eurotronic P/N
- 3.Specification
- 4.Quantity
- 5.Net weight
- 6.Date

Container

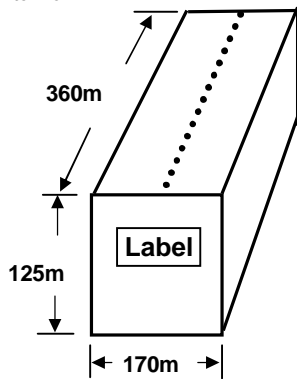

Label:

- 11.Customer P/N
- 2.Eurotronic P/N
- 3.Specification
- 4.Quantity
- 5.Net weight
- 6.Date

Carton

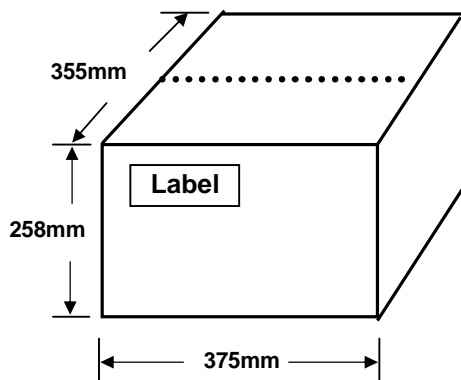

1. (1) Lead Cut: 14 Inner Box PER CARTON
- (2) Long Lead: 4 Inner Box PER CARTON

2. Label:

- A. Customer P/N
- B. Eurotronic P/N
- C. Specification
- D. Quantity
- E. Net weight
- F. Date

RoHS Marking and Barcode Marking

1. Size of Marking

Units: mm

(1) Outer Inner Carton, T/P (Large / Medium Carton)

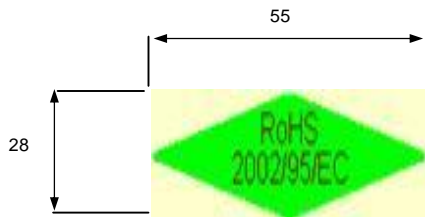

(2) Inner Poly Bag:

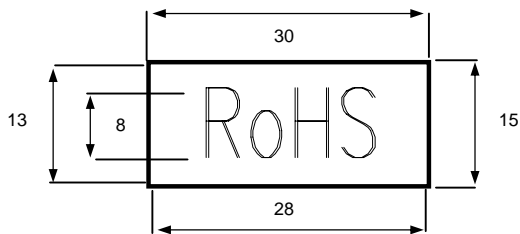

2. Position of Marking

(1) Poly Bag:

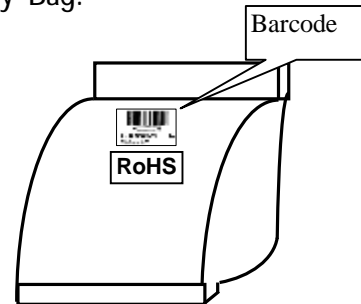

(2) Inner Box (Lead cut) T/P

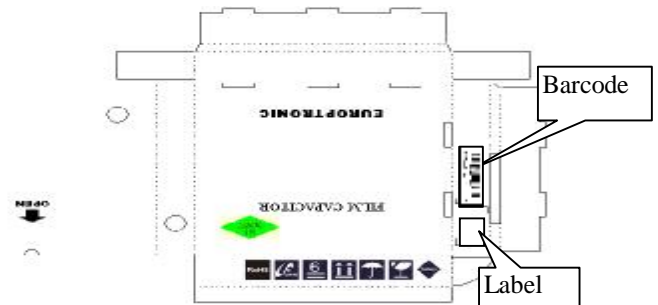

(3) Outer Carton (Large / Medium Carton)

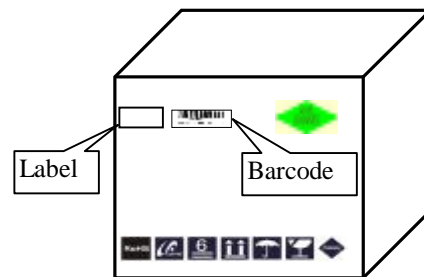

(5) Inner Box (Lead cut) X2

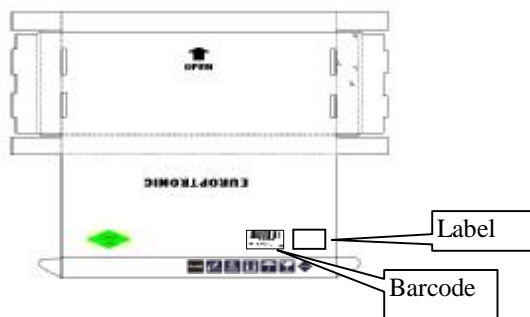

(4) Inner Carton :

