

BA Series

Small, diffuse reflective type with long sensing distance

■ Features

- Realization of long sensing distance (2m) by special optical design
- Protection structure IP64(IEC standard)
- Built-in stability indicator
- Includes sensitivity adjustment function
- 2 color LED display



! Please read "Caution for your safety" in operation manual before using.



■ Specifications

Model	NPN open collector	BA2M-DDT	BA2M-DDTD
	PNP open collector	BA2M-DDT-P	BA2M-DDTD-P
Sensing type	Diffuse reflective		
Sensing distance	2m(Non-glossy white paper 200×200mm)		
Sensing target	Translucent, opaque materials		
Hysteresis	Max. 20% at sensing distance		
Response time	Approx. 1ms		
Power supply	12-24VDC ±10%(Ripple P-P : Max. 10%)		
Current consumption	Max. 15mA(Max. 30mA when the output is ON)		
Light source	Infrared LED(850nm)		
Sensitivity adjustment	Built-in the adjustment VR		
Operation mode	Light ON		Dark ON
Control output	NPN or PNP open collector output ●Load voltage : Max. 26.4VDC ●Load current : Max. 100mA ●Residual voltage - NPN : Max. 1V, PNP : Min. 2.5V		
Protection circuit	Reverse polarity protection, output short-circuit protection		
Indicator	●Operation indicator : red ●Stability indicator : orange(Light ON), green(Dark ON)		
Insulation resistance	Min. 20MΩ(at 500VDC megger)		
Noise resistance	±240V the square wave noise(pulse width : 1μs) by the noise simulator		
Dielectric strength	1000VAC 50/60Hz for 1minute		
Vibration	1.5mm amplitude or 300m/s ² at frequency of 10 to 55Hz(for 1 min.) in each of X, Y, Z directions for 2 hours		
Shock	100m/s ² (approx. 10G) in each of X, Y, Z directions for 3 times		
Environment	Ambient illumination	Sunlight : Max. 11,000lx, Incandescent lamp : Max. 3,000lx (Receiving illumination)	
	Ambient temperature	-25 to 55°C, storage : -25 to 70°C	
	Ambient humidity	35 to 85%RH, storage : 35 to 85%RH	
Protection	IP64(IEC standard)		
Material	Case: ABS, Sensing part: PC, Indicator: PC, VR: IXEF		
Cable	ø3, 3-wire, Length : 2m (AWG24, Core diameter: 0.08mm, Number of cores: 40, Insulator out diameter: ø1)		
Accessory	VR adjustment driver		
Approval	CE		
Unit weight	Approx. 50g		

※The temperature or humidity mentioned in Environment indicates a non freezing or condensation environment.

Diffuse Reflective type with Long Sensing Distance

Feature data

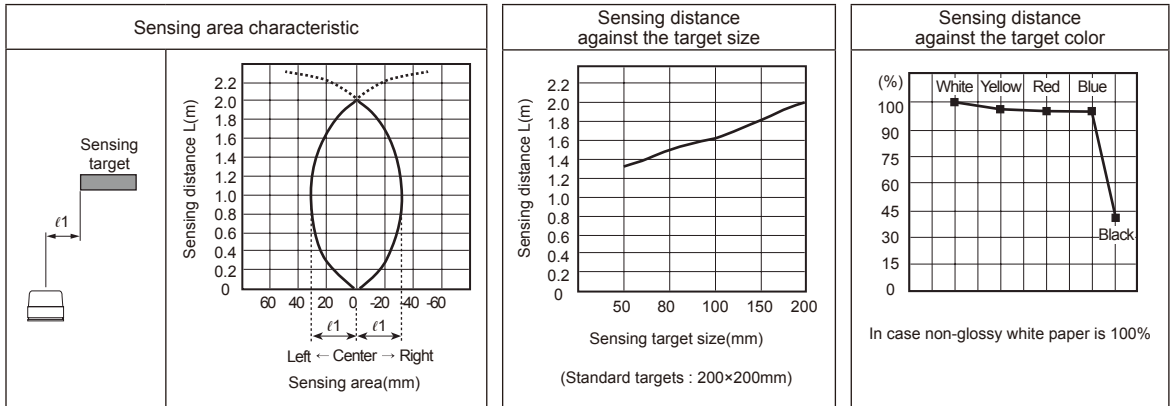

Control output diagram

• NPN open collector output

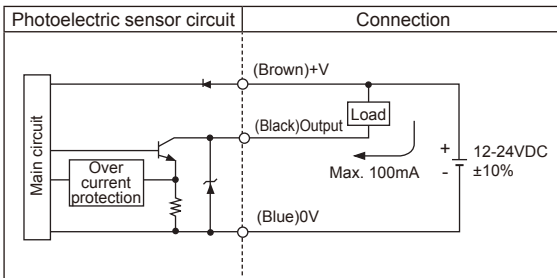

• PNP open collector output

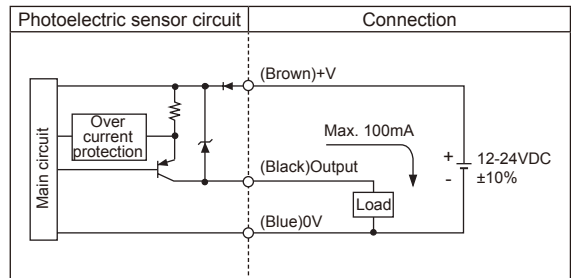

Connections

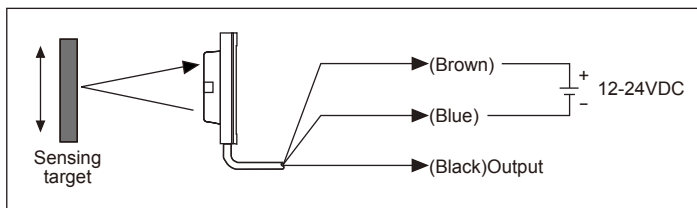

Dimensions

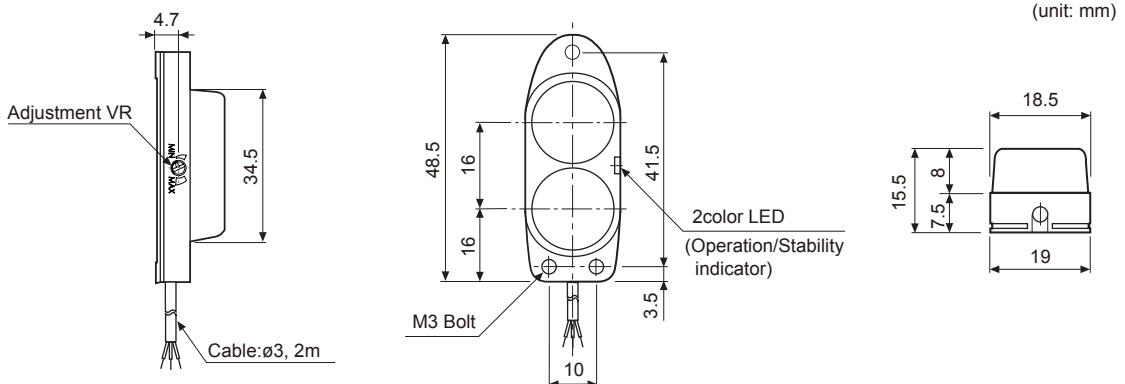

(A) Photo electric sensor

(B) Fiber optic sensor

(C) Door/Area sensor

(D) Proximity sensor

(E) Pressure sensor

(F) Rotary encoder

(G) Connector/Socket

(H) Temp. controller

(I) SSR/ Power controller

(J) Counter

(K) Timer

(L) Panel meter

(M) Tacho/ Speed/ Pulse meter

(N) Display unit

(O) Sensor controller

(P) Switching mode power supply

(Q) Stepper motor& Driver&Controller

(R) Graphic/ Logic panel

(S) Field network device

(T) Software

(U) Other

BA Series

■ Operation mode

If the control output terminal is short-circuit or over current than the rated current flows the unit, the sensor does not operate normally by protection circuit.

● Light ON

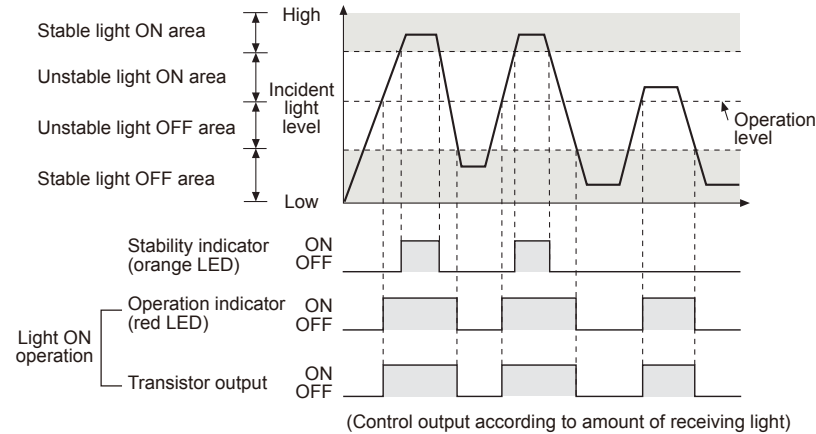

● Dark ON

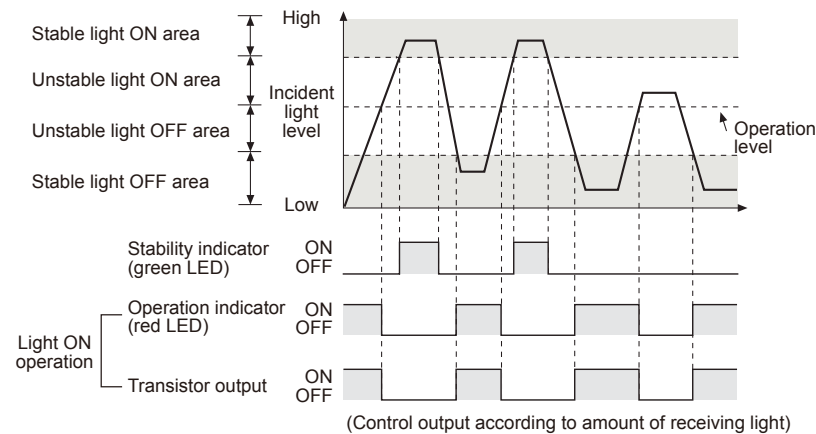

■ Mounting and sensitivity adjustment

Install the sensor to the desired place and check the connections.

Supply the power to the sensor and adjust the optical axis and the sensitivity as follow ;

● Optical axis adjustment

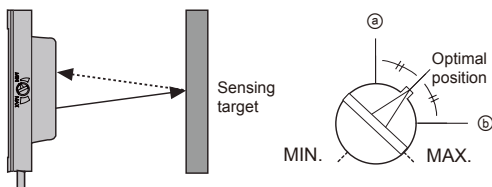

Mount this unit at center position where the stability indicator turns ON as moving the unit toward right or left, up or down.

● Adjustment

1. When sensing the object, set the sensitivity adjustment VR in stable Light ON area (orange: Light On, green: Dark On) as shown '■ Operation mode'.
 2. The sensitivity should be adjusted depending on a sensing target or mounting place.
 3. Set the target at a position to be detected by the beam, then turn the adjustment VR until position ① where the operation indicator turns ON from min. position of the adjustment VR.
 4. Take the target out of the sensing area, then turn the adjustment VR until position ② where the the operation indicator turns ON. If the indicator dose not turn ON, max. position is ②.
 5. Set the adjustment VR at the center of two switching position ①, ②.
- ※ The sensing distance indicated on specification chart is for 200×200mm of non-glossy white paper. Be sure that it can be different by size, surface and gloss of target.